

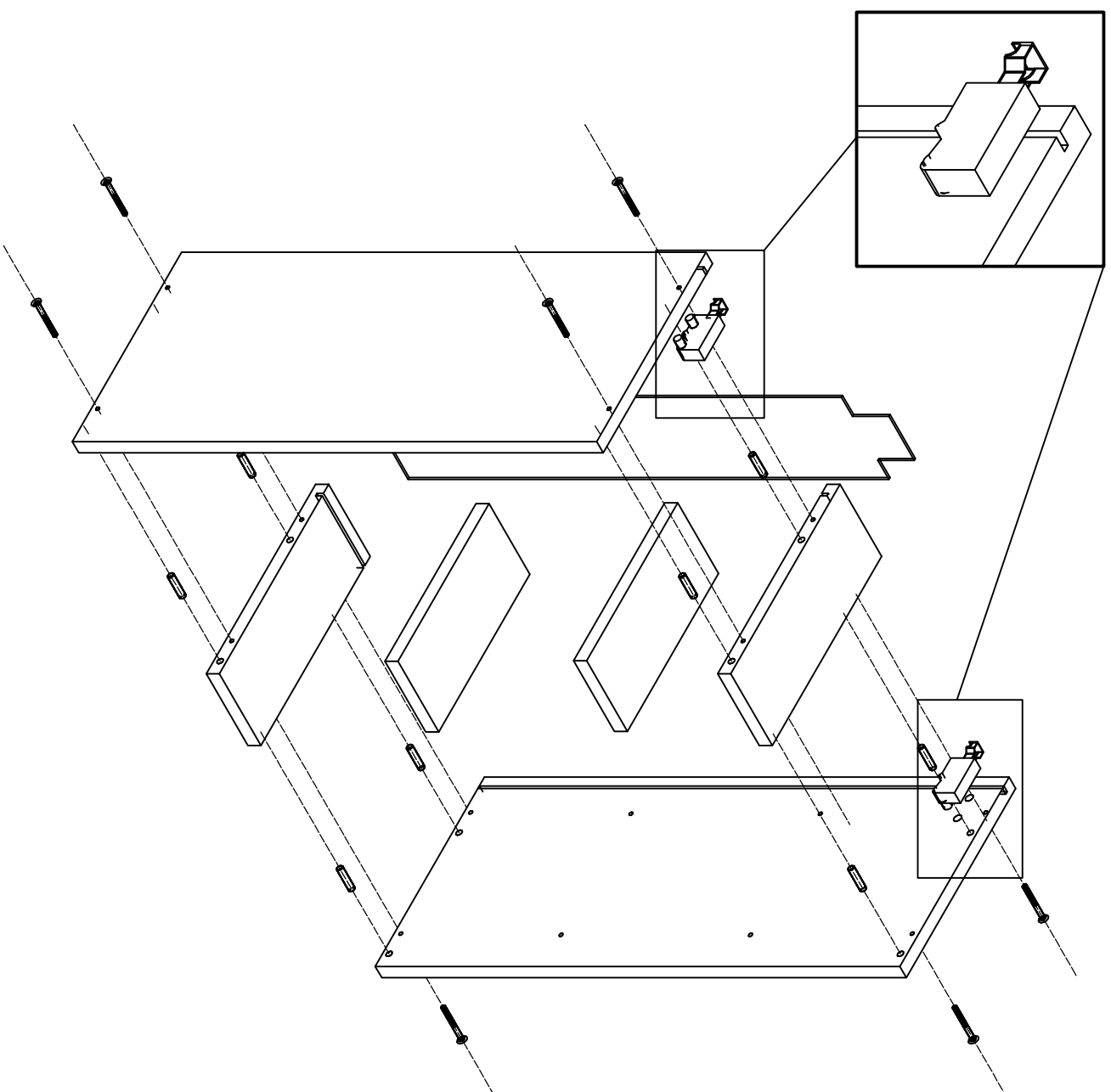

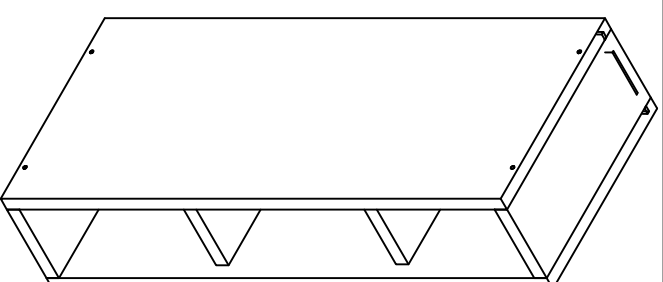



# INSTRUKCJA MONTAŻU SZAFKI GÓRNEJ WO-15



WO-15



## AKCESORIA

 Konfirmat x 8	 Klucz imbus x 1	 Kolek x 8
 Zastępka x 8	 Podpórka boki x 8	 Zawieszka x 2 z bolcami L+P